

Кюветы

Технические характеристики

По вопросам продаж и поддержки обращайтесь:

Алматы (727)345-47-04
Ангарск (3955)60-70-56
Архангельск (8182)63-90-72
Астрахань (8512)99-46-04
Барнаул (3852)73-04-60
Белгород (4722)40-23-64
Благовещенск (4162)22-76-07
Брянск (4832)59-03-52
Владивосток (423)249-28-31
Владикавказ (8672)28-90-48
Владимир (4922)49-43-18
Волгоград (844)278-03-48
Вологда (8172)26-41-59
Воронеж (473)204-51-73
Екатеринбург (343)384-55-89

Иваново (4932)77-34-06
Ижевск (3412)26-03-58
Иркутск (395)279-98-46
Казань (843)206-01-48
Калининград (4012)72-03-81
Калуга (4842)92-23-67
Кемерово (3842)65-04-62
Киров (8332)68-02-04
Коломна (4966)23-41-49
Кострома (4942)77-07-48
Краснодар (861)203-40-90
Красноярск (391)204-63-61
Курск (4712)77-13-04
Курган (3522)50-90-47
Липецк (4742)52-20-81

Магнитогорск (3519)55-03-13
Москва (495)268-04-70
Мурманск (8152)59-64-93
Набережные Челны (8552)20-53-41
Нижний Новгород (831)429-08-12
Новокузнецк (3843)20-46-81
Ноябрьск (3496)41-32-12
Новосибирск (383)227-86-73
Омск (3812)21-46-40
Орел (4862)44-53-42
Оренбург (3532)37-68-04
Пенза (8412)22-31-16
Петрозаводск (8142)55-98-37
Псков (8112)59-10-37
Пермь (342)205-81-47

Ростов-на-Дону (863)308-18-15
Рязань (4912)46-61-64
Самара (846)206-03-16
Санкт-Петербург (812)309-46-40
Саратов (845)249-38-78
Севастополь (8692)22-31-93
Саранск (8342)22-96-24
Симферополь (3652)67-13-56
Смоленск (4812)29-41-54
Сочи (862)225-72-31
Ставрополь (8652)20-65-13
Сургут (3462)77-98-35
Сыктывкар (8212)25-95-17
Тамбов (4752)50-40-97
Тверь (4822)63-31-35

Тольятти (8482)63-91-07
Томск (3822)98-41-53
Тула (4872)33-79-87
Тюмень (3452)66-21-18
Ульяновск (8422)24-23-59
Улан-Удэ (3012)59-97-51
Уфа (347)229-48-12
Хабаровск (4212)92-98-04
Чебоксары (8352)28-53-07
Челябинск (351)202-03-61
Череповец (8202)49-02-64
Чита (3022)38-34-83
Якутск (4112)23-90-97
Ярославль (4852)69-52-93

Россия +7(495)268-04-70

Казахстан +(727)345-47-04

Беларусь +(375)257-127-884

Узбекистан +998(71)205-18-59

Киргизия +996(312)96-26-47

эл.почта: kja@nt-rt.ru || сайт: <https://kangjian.nt-rt.ru>



081-101
(KJ133)



081-102
(KJ134)



081-103
(KJ135)



081-104
(KJ136)



081-105
(KJ139)



081-106
(KJ111)



081-107
(KJ111-1)



081-108
(KJ111-2)



081-109
(KJ112-1)







081-110
(KJ112-2)

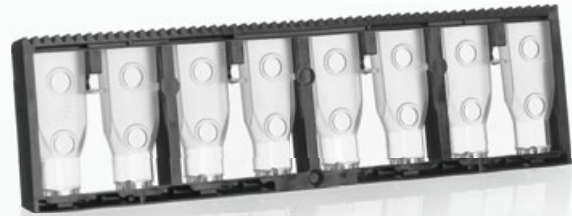





081-111
(KJ104)



081-112
(KJ104-1)

REF	Original REF.	MAT					
081-101	KJ133	PS	12.5×12.5×45mm		100	2000	Application: 340-800mm
081-102	KJ134	PS	12.5×12.5×45mm		100	2000	Application: 340-800mm
081-103	KJ135	PS	12.5×12.5×45mm		100	2000	Application: 340-800mm
081-104	KJ136	PS	12.5×12.5×45mm		100	2000	Application: 340-800mm
081-105	KJ139	PS	15.7×11.8×46mm		100	2000	
081-106	KJ111	PS	∅15×35mm	2000		20000	For Sysmex CA 530
081-107	KJ111-1	PS	∅15×35mm	1000		24000	For Sysmex CA 7000
081-108	KJ111-2	PS	∅15×35mm	3000		24000	For Sysmex CA 1500
081-109	KJ112-1	PS	∅15×35mm	2000		24000	For Sysmex CA 2000i
081-110	KJ112-2	PS	∅8.8×30mm	2000		20000	For SEKISUI
081-111	KJ104	PS	60×32mm	29		2001	For German BE Automatic
081-112	KJ104-1	PS	119×32mm	8		1160	For German BE Automatic



REF	Original REF.	MAT					
081-113	KJ101	PS	7.5×8×23mm	1000		25000	For German BE 1 Channel
081-114	KJ102	PS	7.5×29×21mm	600		6000	For German BE 2 Channel
081-115	KJ103	PS	7.5×61×21mm	300		6000	For German BE 4 Channel
081-116	KJ105	PS	11×30×27mm	100		4000	For German BECL4 2 Channel
081-117	KJ106	PS	11×60×27mm	50		1000	For German BECL4 4 Channel
081-118	KJ107	PS	11×120×27mm	25		500	For German BECL4 8 Channel
081-119	KJ108	PS	Ø17×26mm	1000		10000	For German TECO
081-120	KJ109	PS	11×31×19mm	1000		10000	For German TECO 2 Channel
081-121	KJ110	PS	Ø10×19mm	1000		25000	For German TECO 1 Channel
081-122	KJ110-1	PS	Ø10×23mm	1000		25000	For German TECO 1 Channel
081-123	KJ114	PS	7.5×8×23mm	1000		10000	For Spain Cruor Apparatus
081-124	KJ115	PS	11×120×27mm	1000		10000	For German LABOR



081-125
(KJ124)



081-126
(KJ125)



081-127
(KJ132)



081-128
(KJ137)



081-129
(KJ138)



081-130
(KJ116)



081-131
(KJ118)



081-132
(KJ122)



081-133
(KJ120)



081-134
(KJ121)

REF

Original
REF.

MAT



081-125

KJ124

PS

11×60×27mm

50

3000

For Beijing Perlong

081-126

KJ125

PS

11×30×27mm

25

500

For Swiss SEROZYME

081-127

KJ132

PS

Ø11×23mm

1000

10000

For Sigma KC-40

081-128

KJ137

PS

Ø12×30mm

1000

10000

FC Serum Cup

081-129

KJ138

PS

Ø10×30mm

1000

10000

FC Serum Cup

081-130

KJ116

PS

47.5×9×27mm

200

4000

For American Pacific

081-131

KJ118

PS

45×19×28mm

100

2000

For Zhongshan Peikang

081-132

KJ122

PS

Ø108mm

1

500

For American Coulter

081-133

KJ120

PS

66.5×16×24mm

175

2100

For Precil / For French STAGO

081-134

KJ121

PS

66×16×30mm

140

2800

For Steellex

081-135
(KJ123)



081-136
(KJ127)

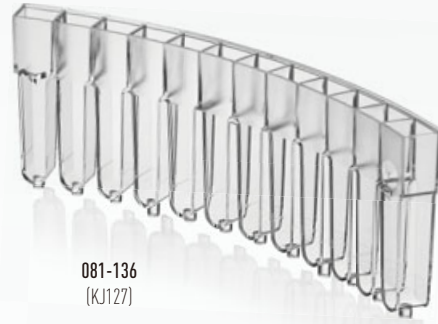

081-137
(KJ128)

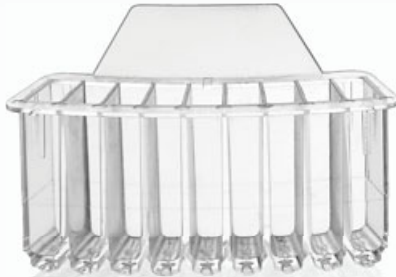

081-138
(KJ129)



081-139
(KJ130)



REF

Original
REF.

MAT



081-135

KJ123

PS

96×9×18mm

2000

For Beckman

081-136

KJ127

PS

96×9×18mm

400

For Roche

081-137

KJ128

PS

1200

For Specific Protein Analyzer

081-138

KJ129

PS

2000

For BN100 Specific Protein Analyzer

081-139

KJ130

PS

1200

For French Biomerieux

По вопросам продаж и поддержки обращайтесь:

Алматы (727)345-47-04
Ангарск (3955)60-70-56
Архангельск (8182)63-90-72
Астрахань (8512)99-46-04
Барнаул (3852)73-04-60
Белгород (4722)40-23-64
Благовещенск (4162)22-76-07
Брянск (4832)59-03-52
Владивосток (423)249-28-31
Владикавказ (8672)28-90-48
Владимир (4922)49-43-18
Волгоград (844)278-03-48
Вологда (8172)26-41-59
Воронеж (473)204-51-73
Екатеринбург (343)384-55-89

Иваново (4932)77-34-06
Ижевск (3412)26-03-58
Иркутск (395)279-98-46
Казань (843)206-01-48
Калининград (4012)72-03-81
Калуга (4842)92-23-67
Кемерово (3842)65-04-62
Киров (8332)68-02-04
Коломна (4966)23-41-49
Кострома (4942)77-07-48
Краснодар (861)203-40-90
Красноярск (391)204-63-61
Курск (4712)77-13-04
Курган (3522)50-90-47
Липецк (4742)52-20-81

Магнитогорск (3519)55-03-13
Москва (495)268-04-70
Мурманск (8152)59-64-93
Набережные Челны (8552)20-53-41
Нижний Новгород (831)429-08-12
Новокузнецк (3843)20-46-81
Ноябрьск (3496)41-32-12
Новосибирск (383)227-86-73
Омск (3812)21-46-40
Орел (4862)44-53-42
Оренбург (3532)37-68-04
Пенза (8412)22-31-16
Петрозаводск (8142)55-98-37
Псков (8112)59-10-37
Пермь (342)205-81-47

Ростов-на-Дону (863)308-18-15
Рязань (4912)46-61-64
Самара (846)206-03-16
Санкт-Петербург (812)309-46-40
Саратов (845)249-38-78
Севастополь (8692)22-31-93
Саранск (8342)22-96-24
Симферополь (3652)67-13-56
Смоленск (4812)29-41-54
Сочи (862)225-72-31
Ставрополь (8652)20-65-13
Сургут (3462)77-98-35
Сыктывкар (8212)25-95-17
Тамбов (4752)50-40-97
Тверь (4822)63-31-35

Тольятти (8482)63-91-07
Томск (3822)98-41-53
Тула (4872)33-79-87
Тюмень (3452)66-21-18
Ульяновск (8422)24-23-59
Улан-Удэ (3012)59-97-51
Уфа (347)229-48-12
Хабаровск (4212)92-98-04
Чебоксары (8352)28-53-07
Челябинск (351)202-03-61
Череповец (8202)49-02-64
Чита (3022)38-34-83
Якутск (4112)23-90-97
Ярославль (4852)69-52-93

Россия +7(495)268-04-70

Казахстан +(727)345-47-04

Беларусь +(375)257-127-884

Узбекистан +998(71)205-18-59

Киргизия +996(312)96-26-47

эл.почта: kja@nt-rt.ru || сайт: <https://kangjian.nt-rt.ru>